



ARCHITECTURE

with sauce

Print out all parts and paint them in your favorite colors, before cutting them out.

Glue the page containing the building body onto a piece of thick paper.

Cut out all parts with scissors.

Use a ruler and a wooden stick to scratch the black dashed lines, this will make them fold easier.

Add all parts to the body step by step. The instructions on the next page will help you to do so. Afterwards, decorate your tower!



The Shard

CRAFTING MODEL

JUNIOR VERSION
SIMPLIFIED

The creation of this crafting set
was made possible by:



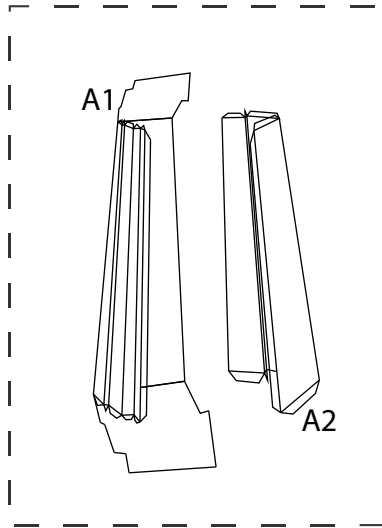

Start with the base.
Fold two parts
and glue them.

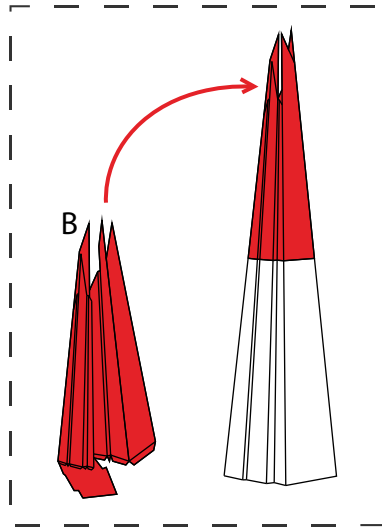

Fold the top part,
and glue it on
top of the base.

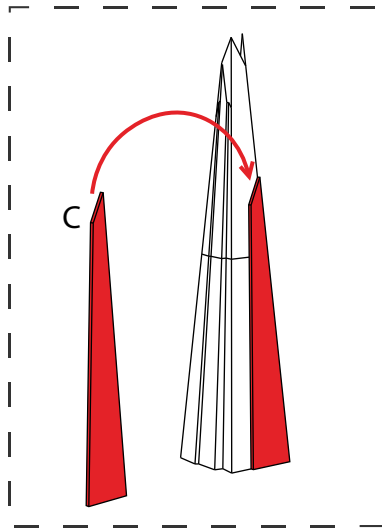

Fold the side part
and attach it to
the front of the base.

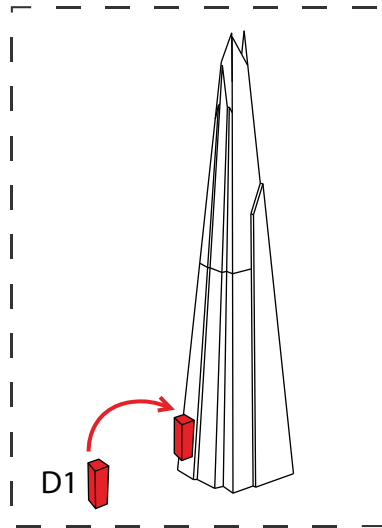

Fold the first extension
and attach it to the
side of the base.

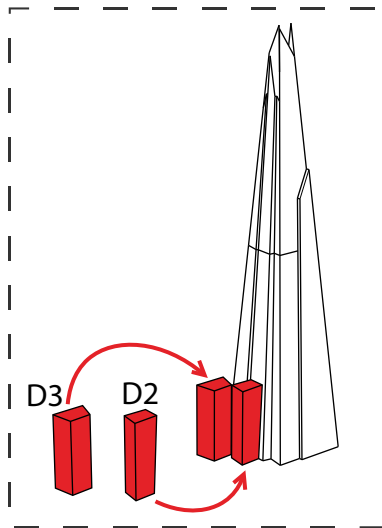

Fold the remaining
extensions and stick them
to the side of the base.

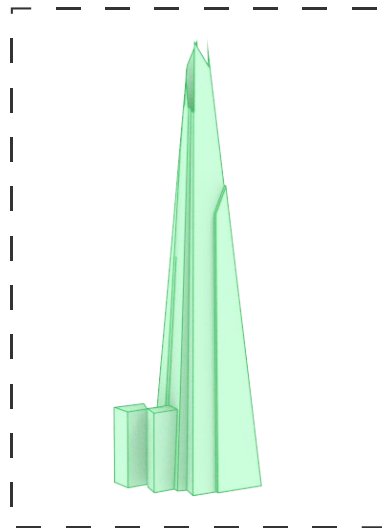

Congratulations, you did it!
To share your artwork with others,
please see the last page.

A1 (body base)

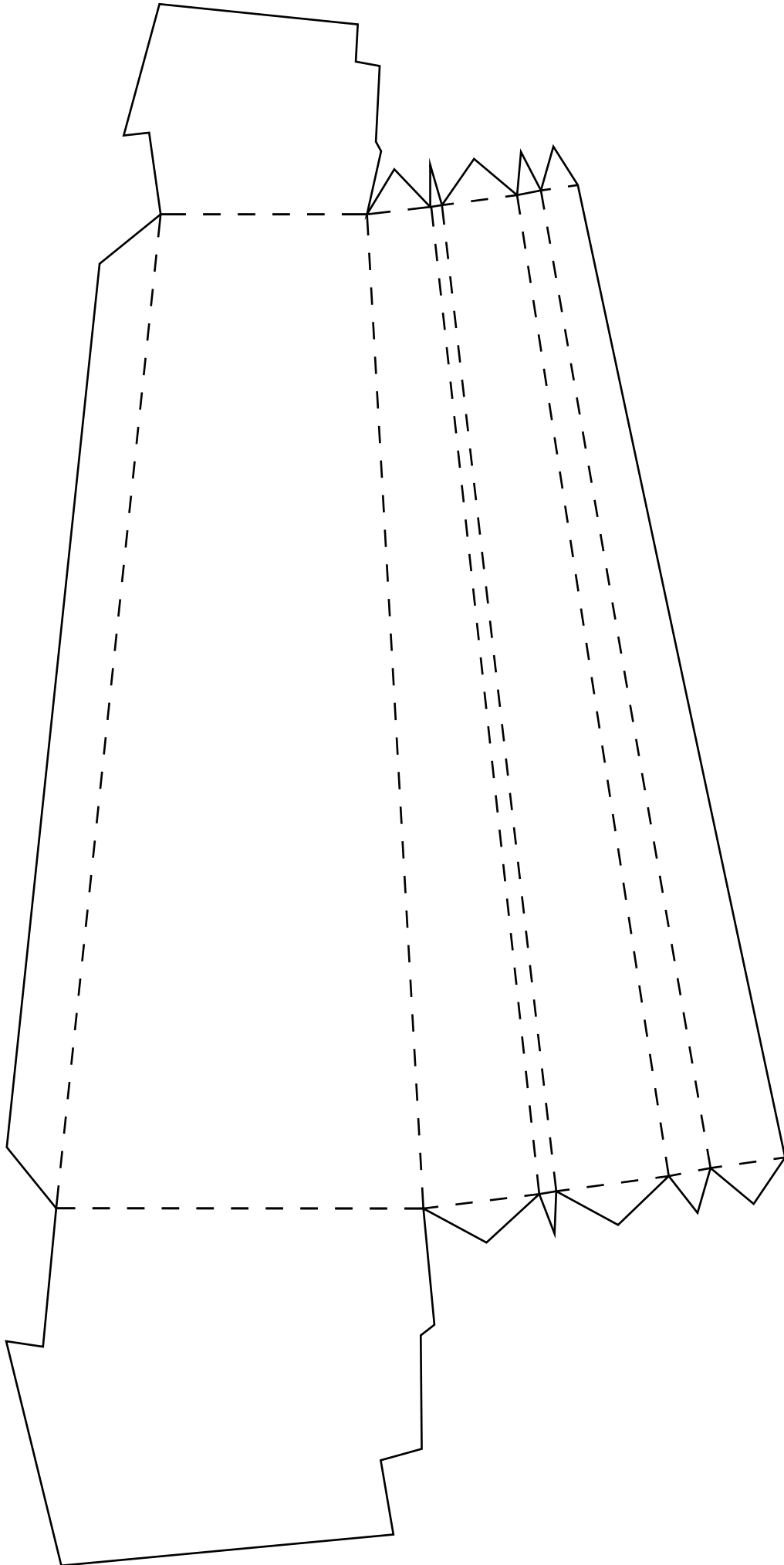

A2 (body base)

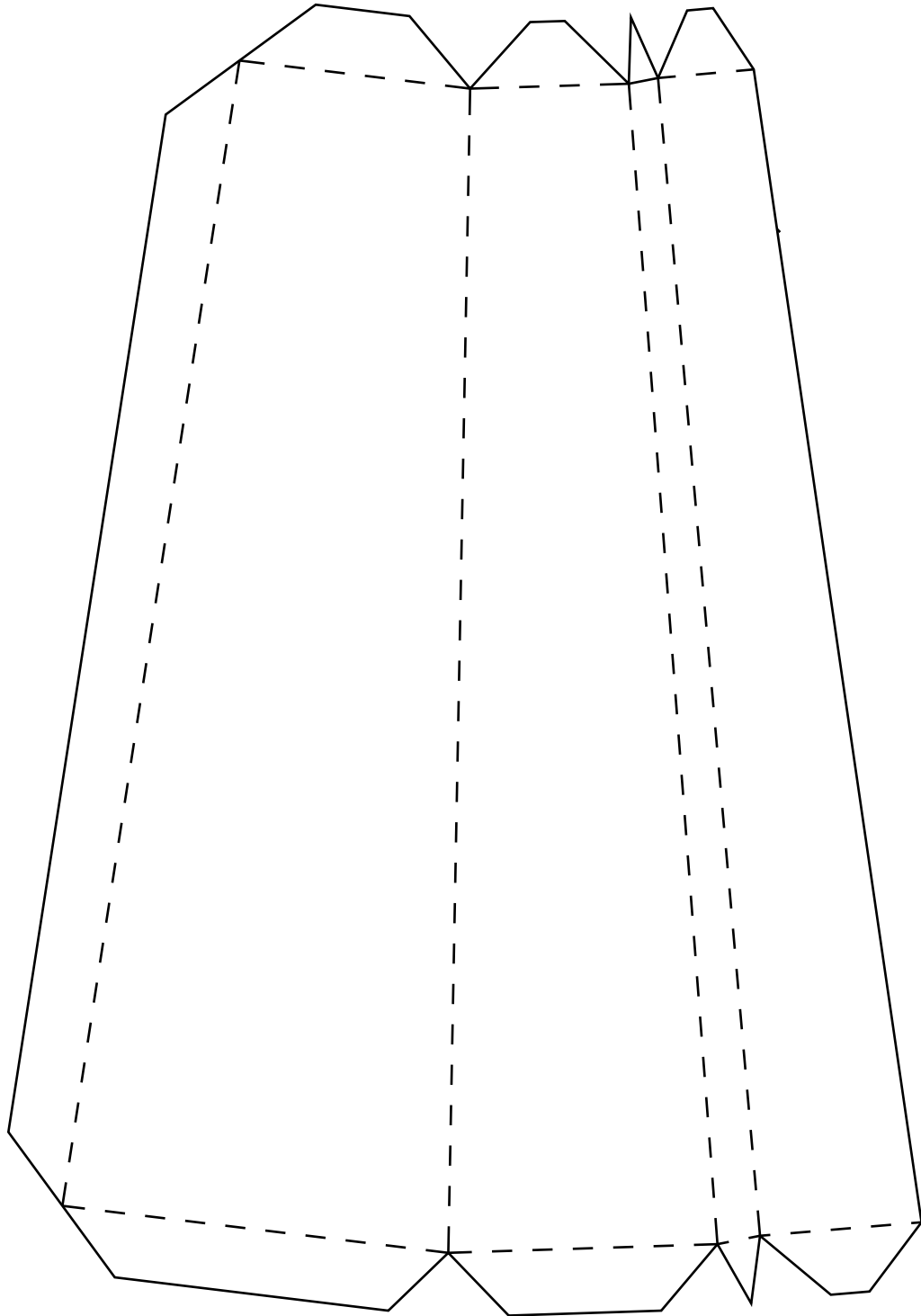

B (body top)

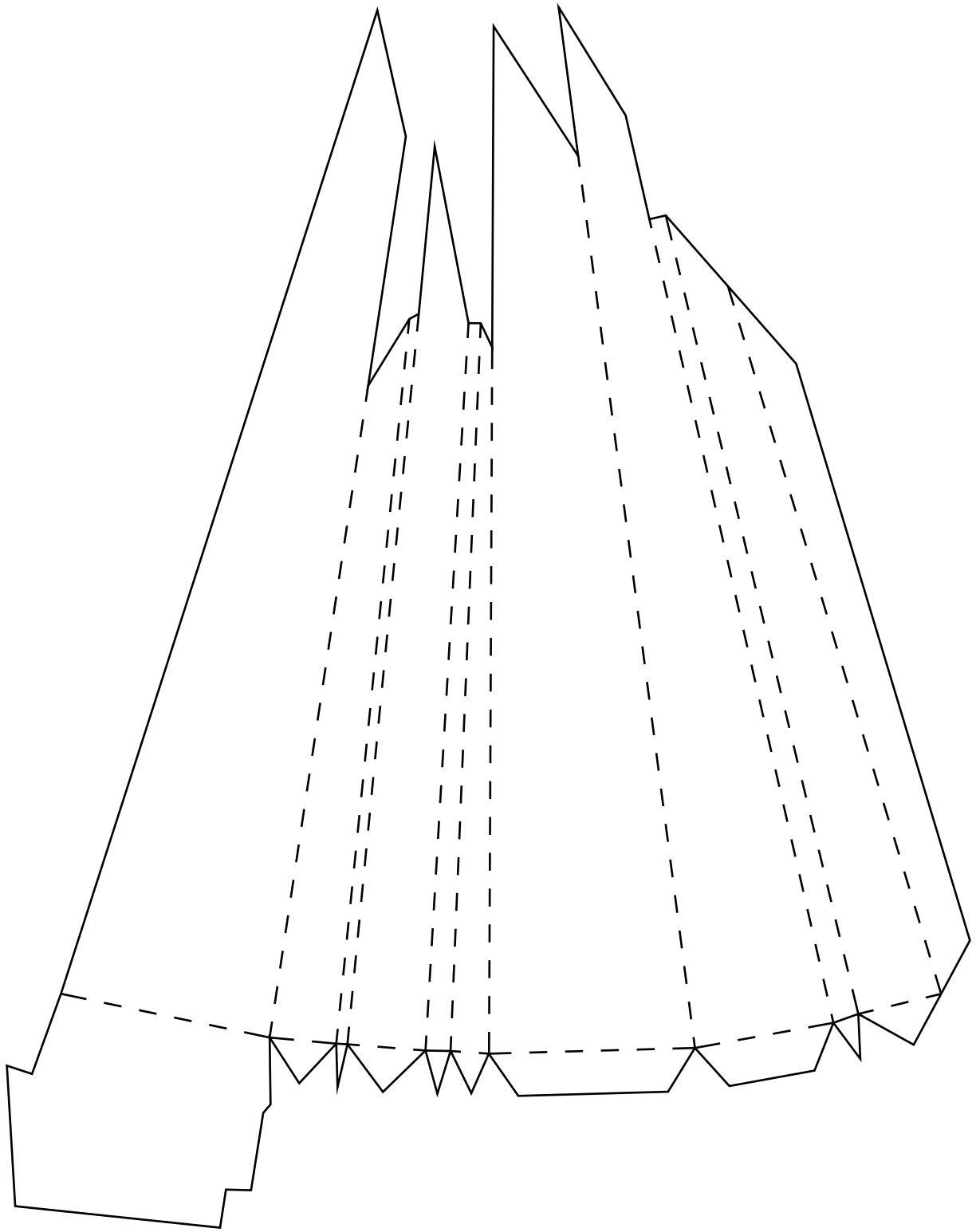

C (body side part)

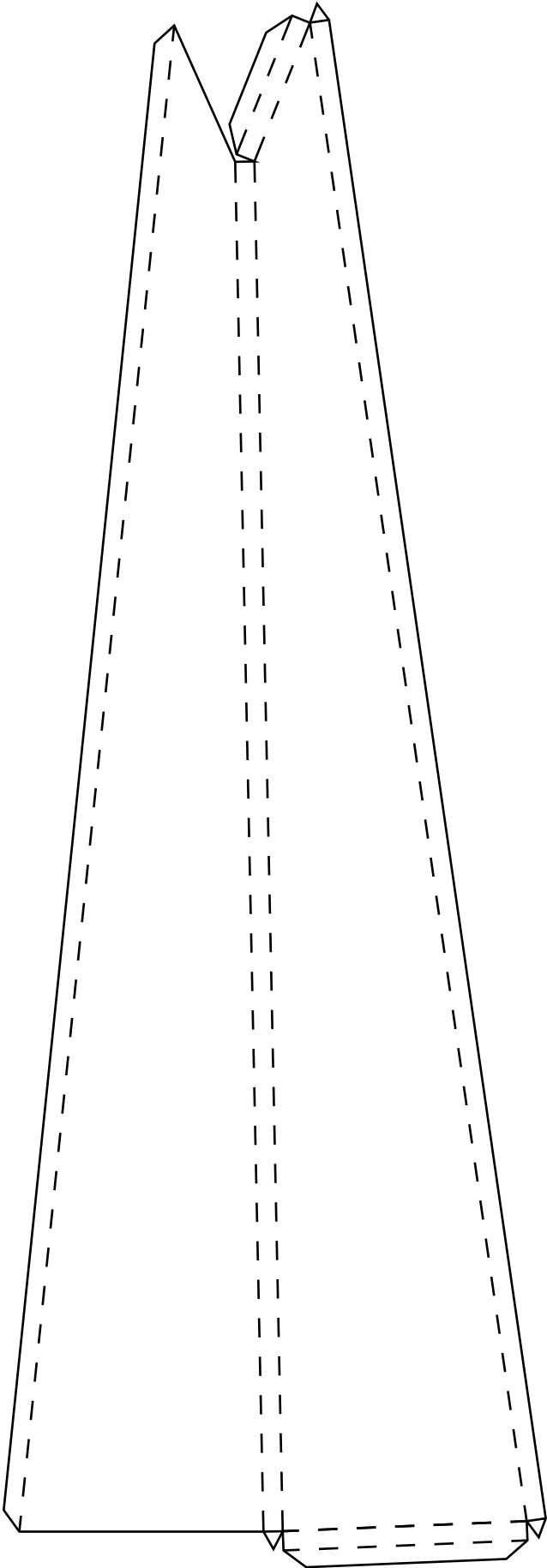

D (body extensions)

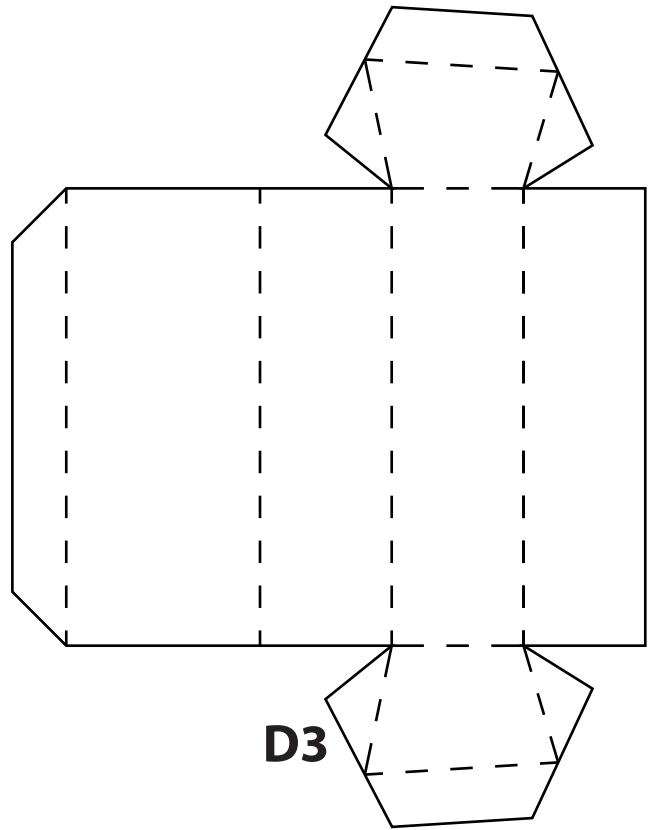
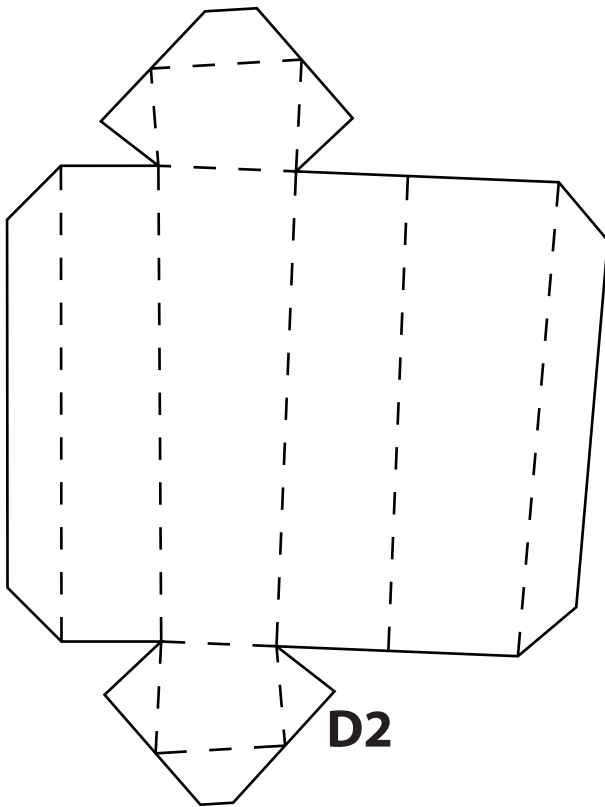
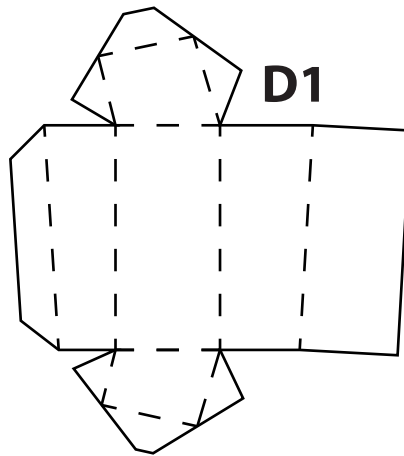



ARCHITECTURE

with sauce 

This tinker set has been provided by ARCHITECTURE with sauce, a project dedicated to offer crafting models.

Be sure to upload your building to the official gallery after you decorated it with colors or glitter: www.craftingmodels.com/upload/

You can share your artwork on social media using the tags #craftingmodel #london and #theshard.

Hungry for building more? You can download additional crafting sets directly online at www.craftingmodels.com



The Shard

CRAFTING MODEL 1:1000

difficulty: medium



Visit the world's largest database of skyscrapers and tall buildings on www.skydb.net. Be sure to also follow @skydb_net on social media.