



# ARCHITECTURE

*with sauce* 

Print out all parts and paint them in your favorite colors, before cutting them out.

Glue the page containing the building body onto a piece of thick paper.

Cut out all parts with scissors.

Use a ruler and a wooden stick to scratch the black dashed lines, this will make them fold easier.

Add all parts to the body step by step. The instructions on the next page will help you to do so. Afterwards, decorate your tower!



## Burj Al Arab

CRAFTING MODEL

JUNIOR VERSION

SIMPLIFIED

The creation of this crafting set  
was made possible by:



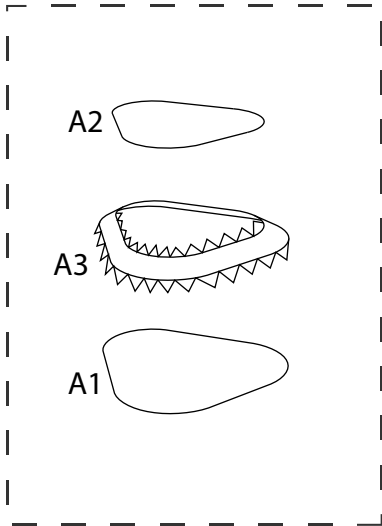

Start with the base part of the building body, fold it and assemble it.

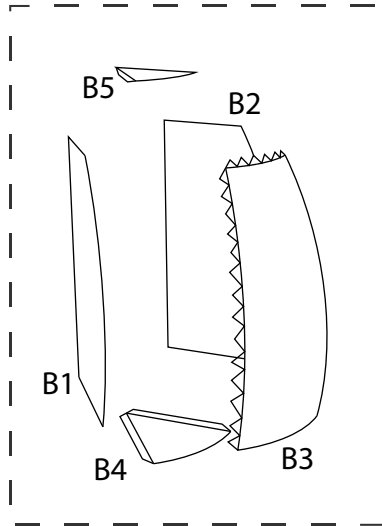

Fold the main body parts and create the main body.

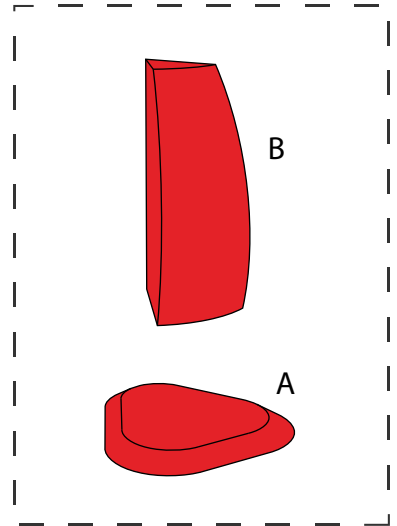

Now you have two parts which need to be stuck together.

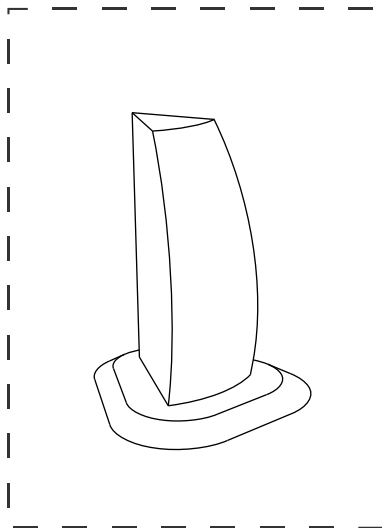

Now you have formed the body of the building.

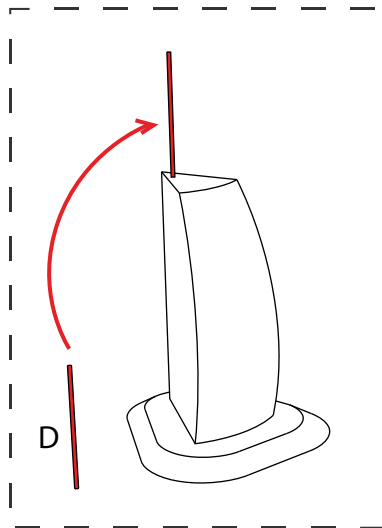

Then, roll the antenna and stick it to the top of the building.

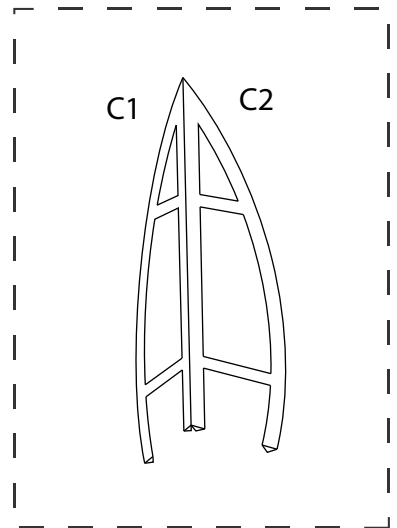

Fold the side parts and connect them.

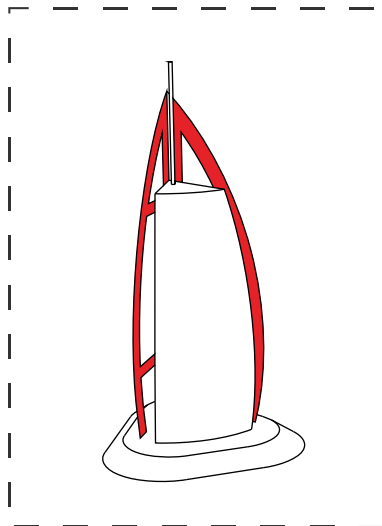

Stick the side parts to the building.

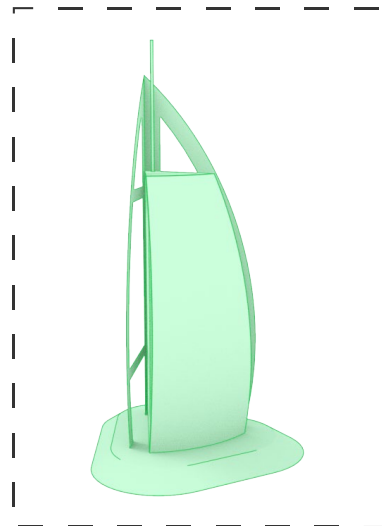

Congratulations, you did it!  
To share your artwork with others, please see the last page.

**A1** (base)

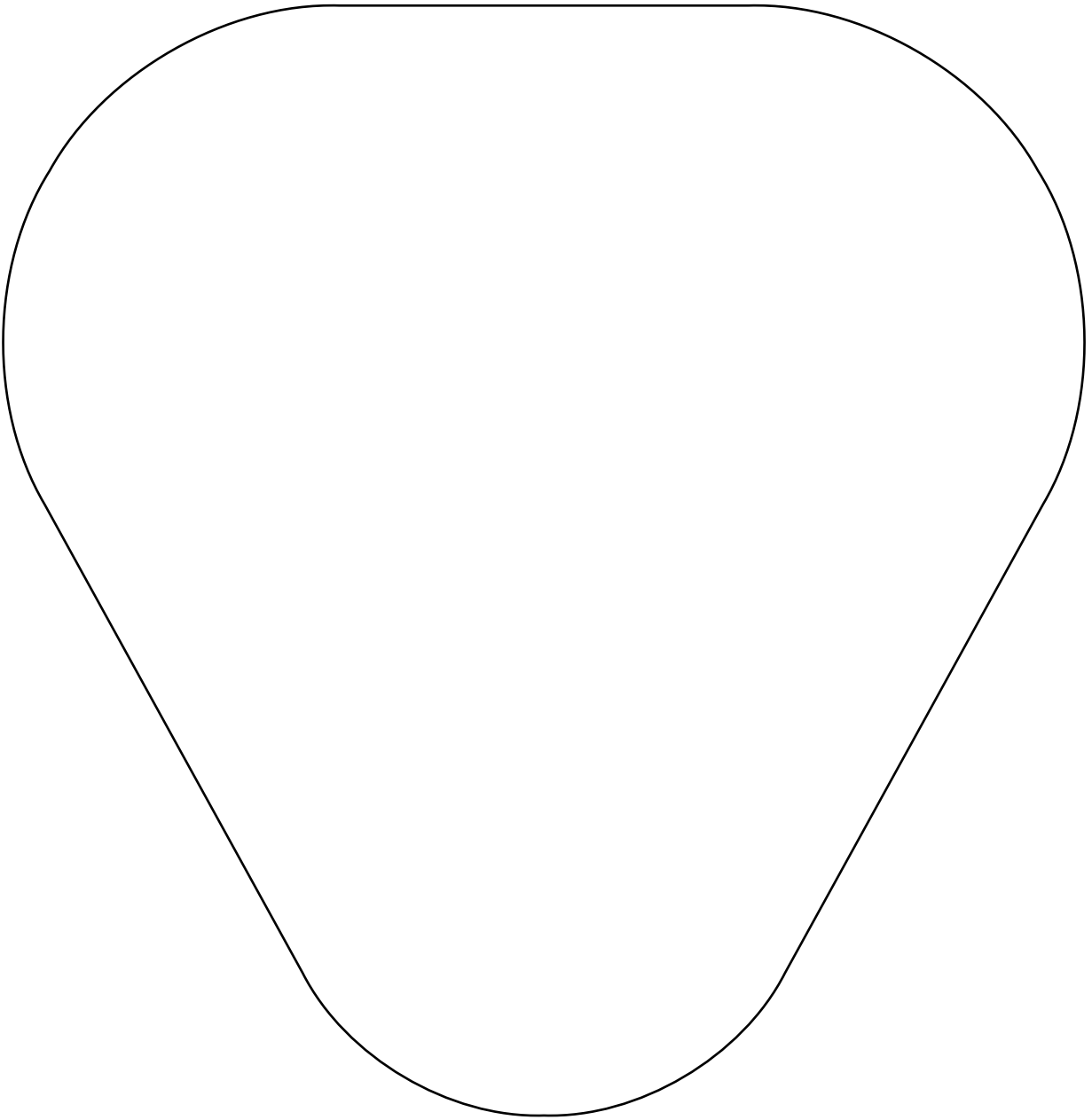

**A2** (base top)

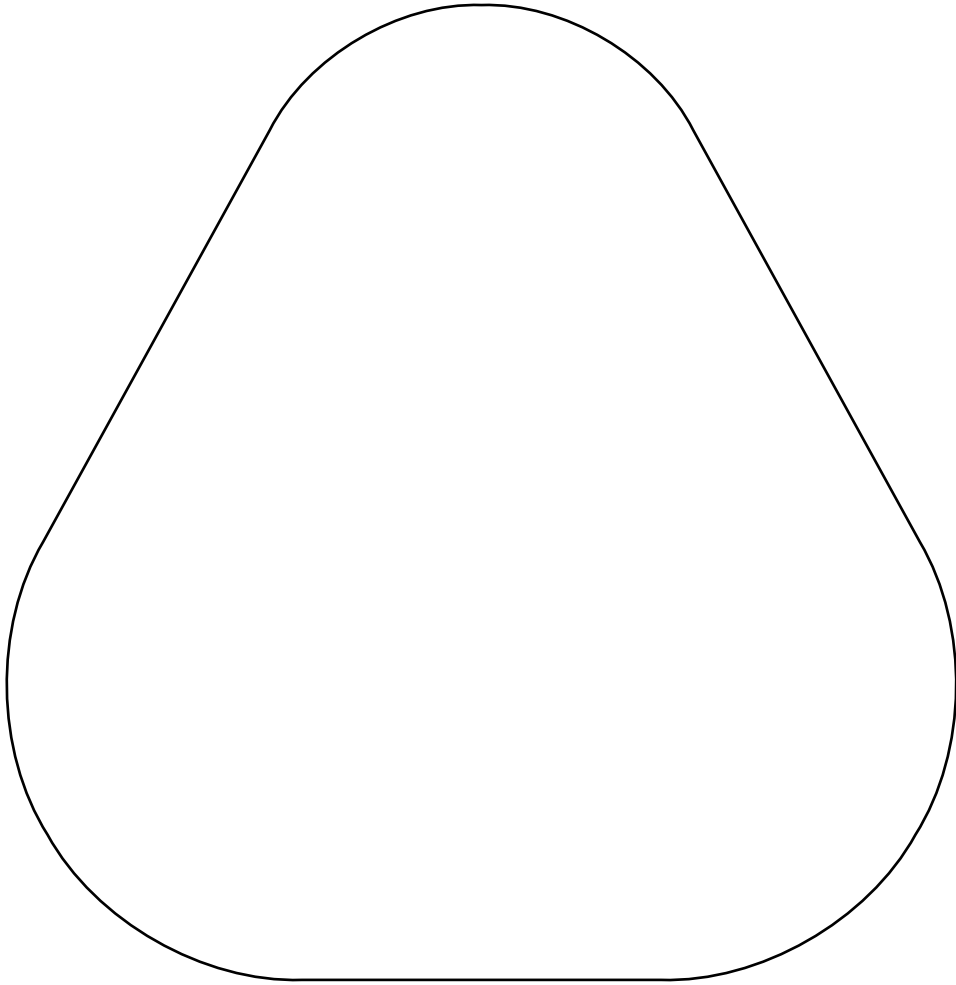

**B** (main body)

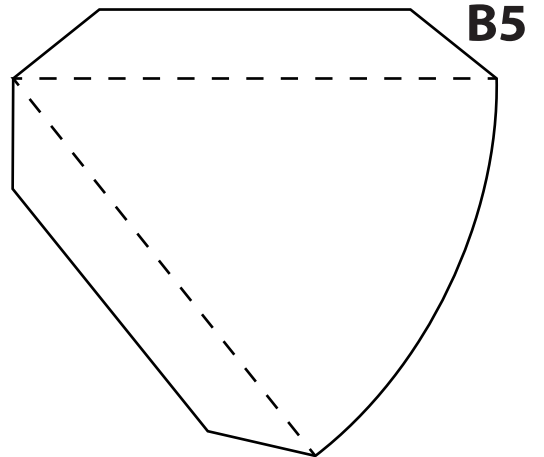
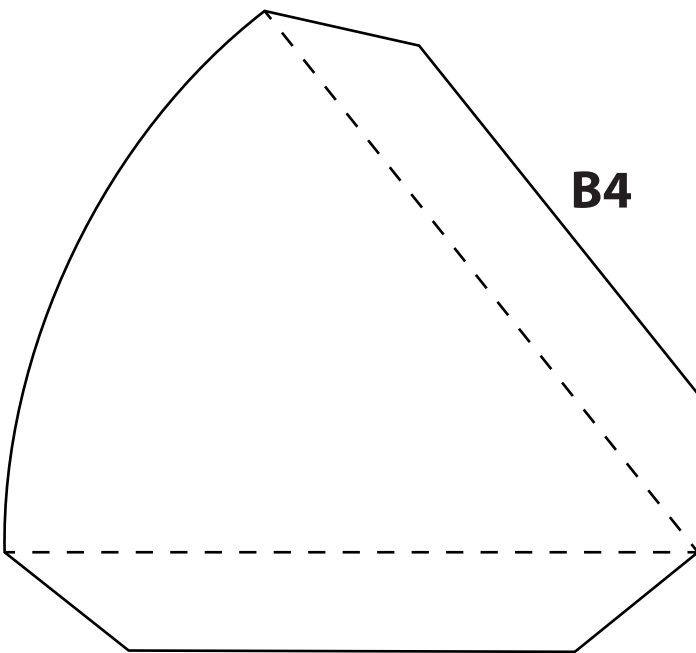

**A3** (base middle)

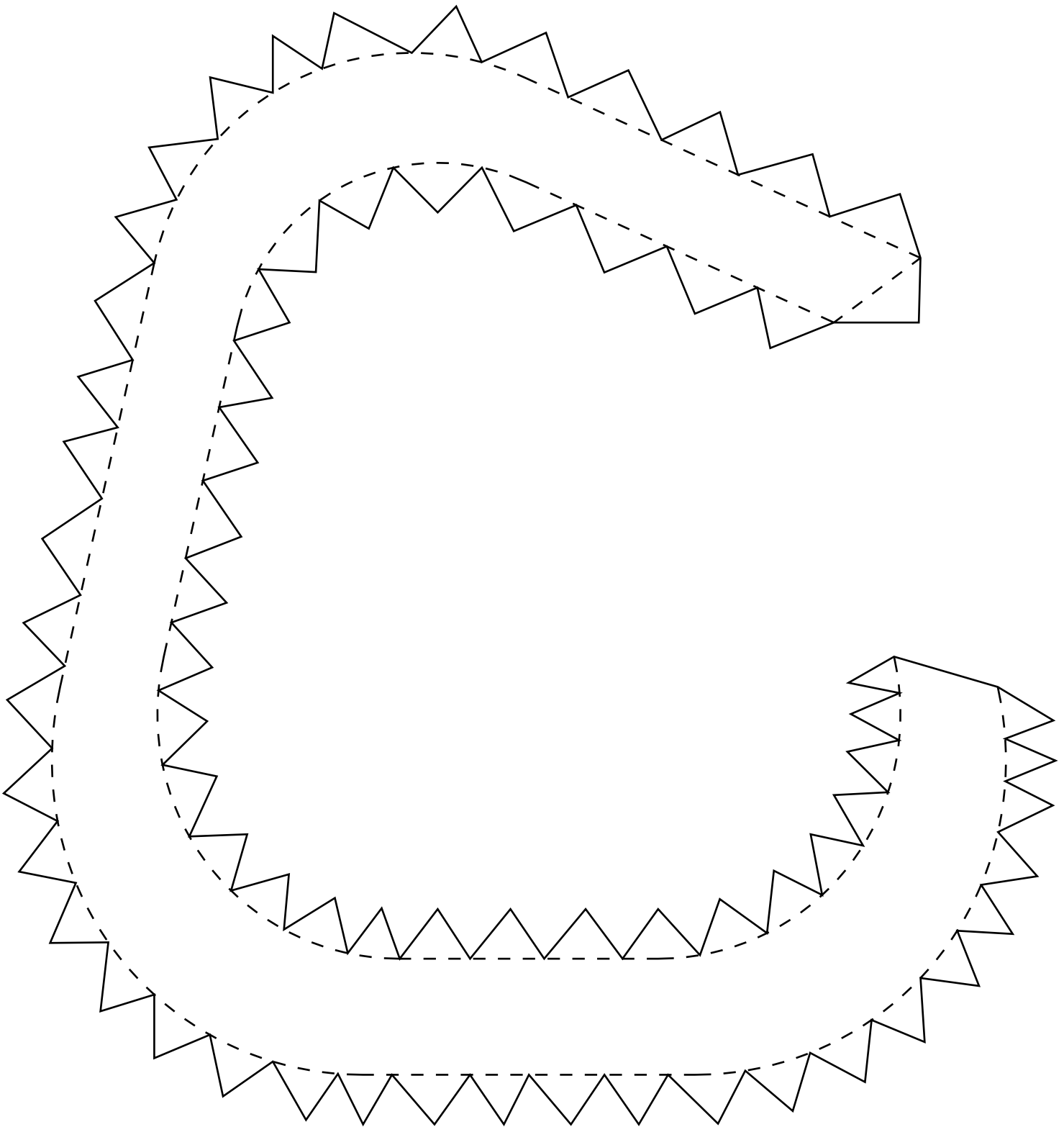

**D** (antenna)

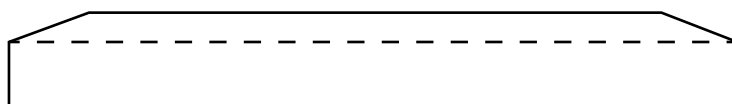

**B** (main body)

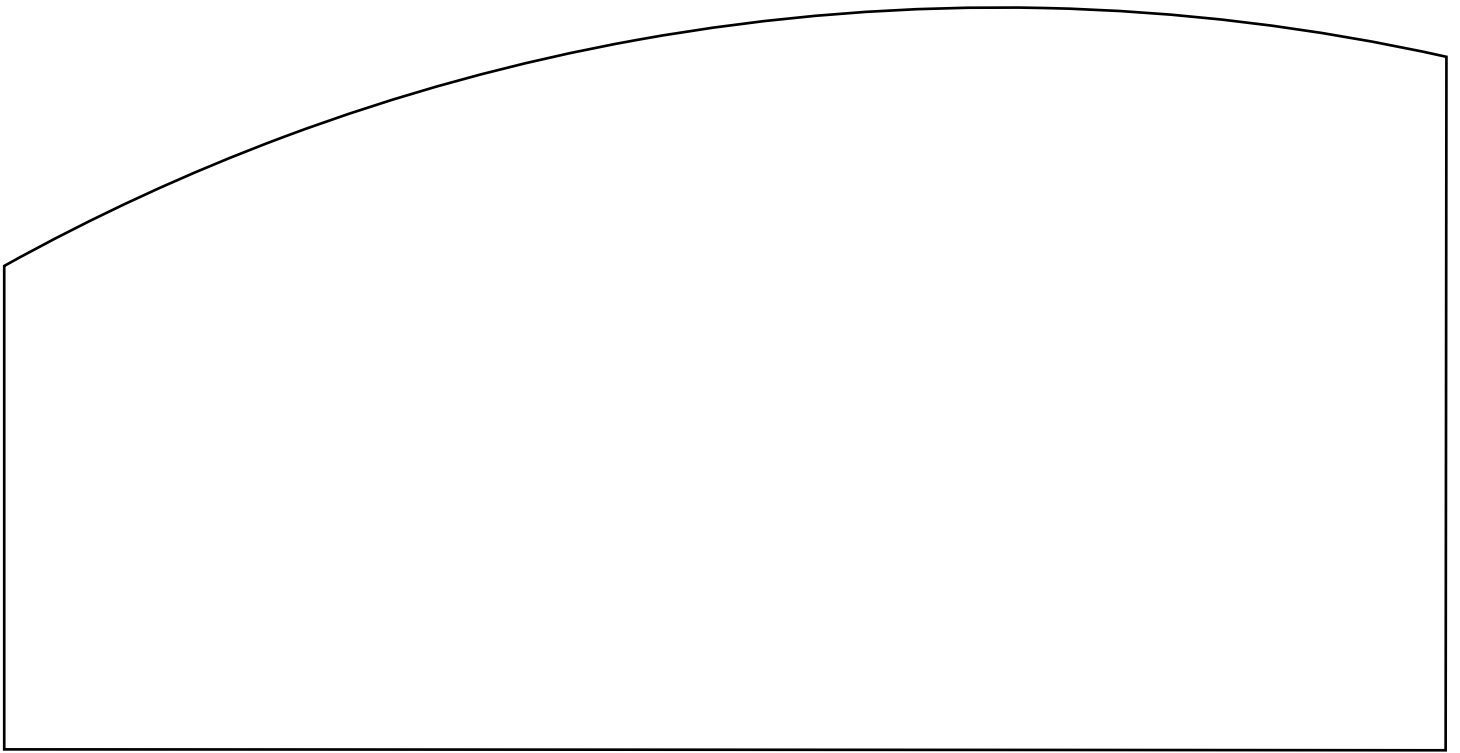

**B1**

**B2**

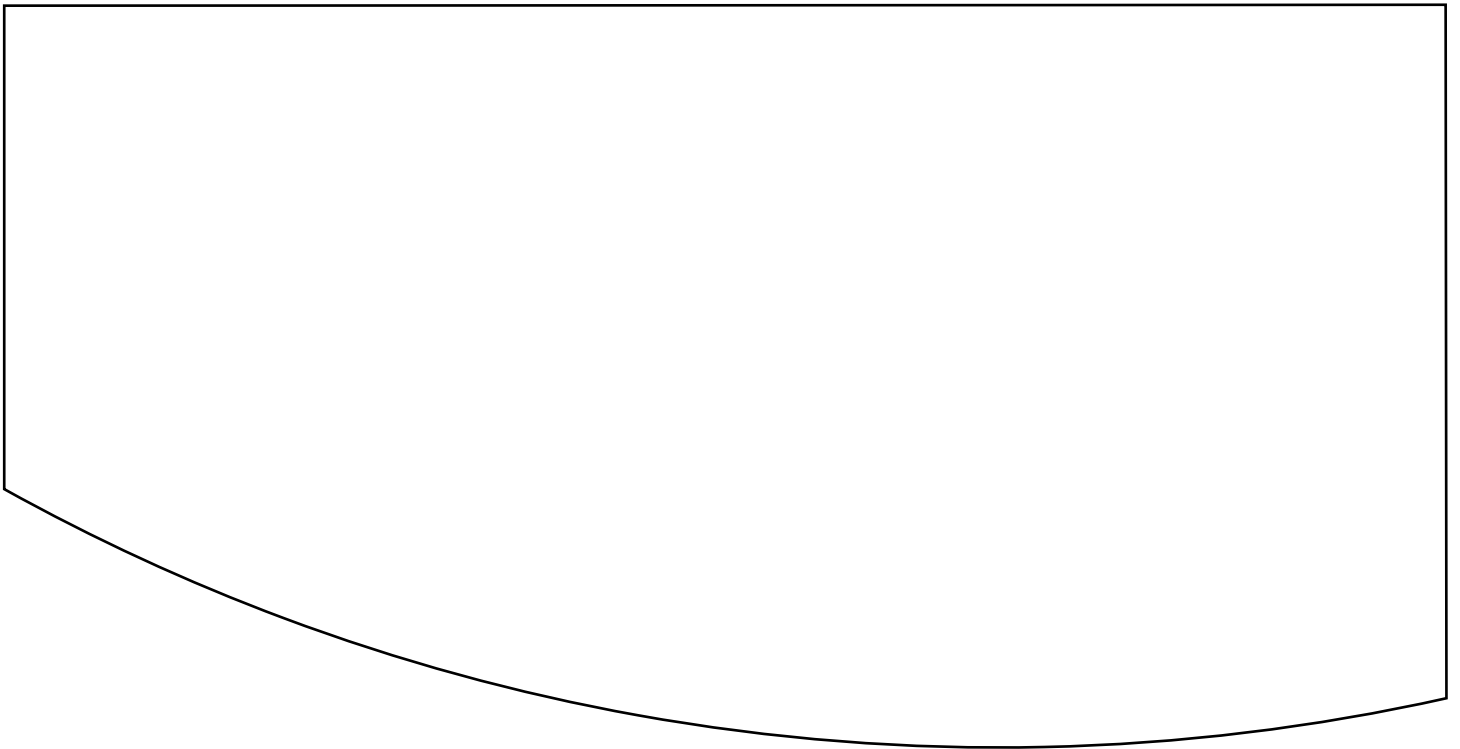

**B (main body)**

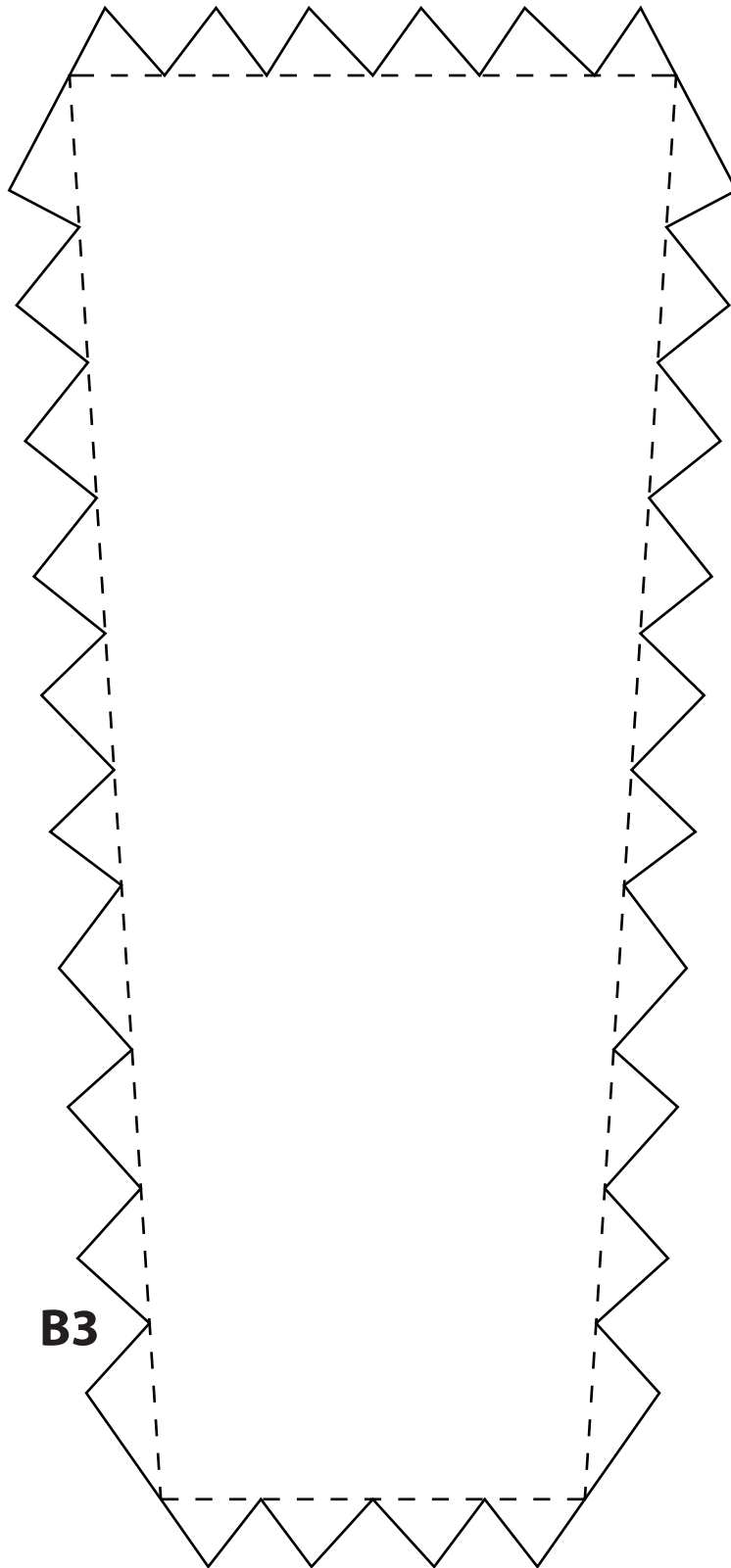

**C1** (side part)

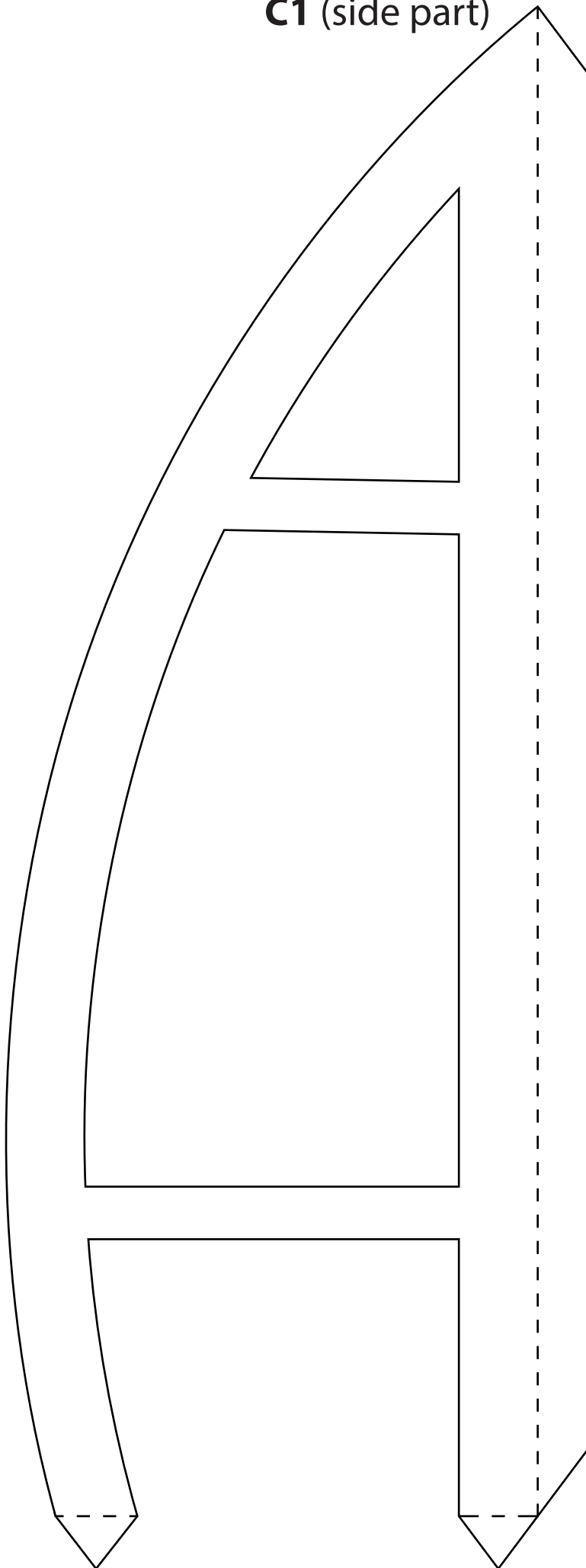



**C2 (side part)**

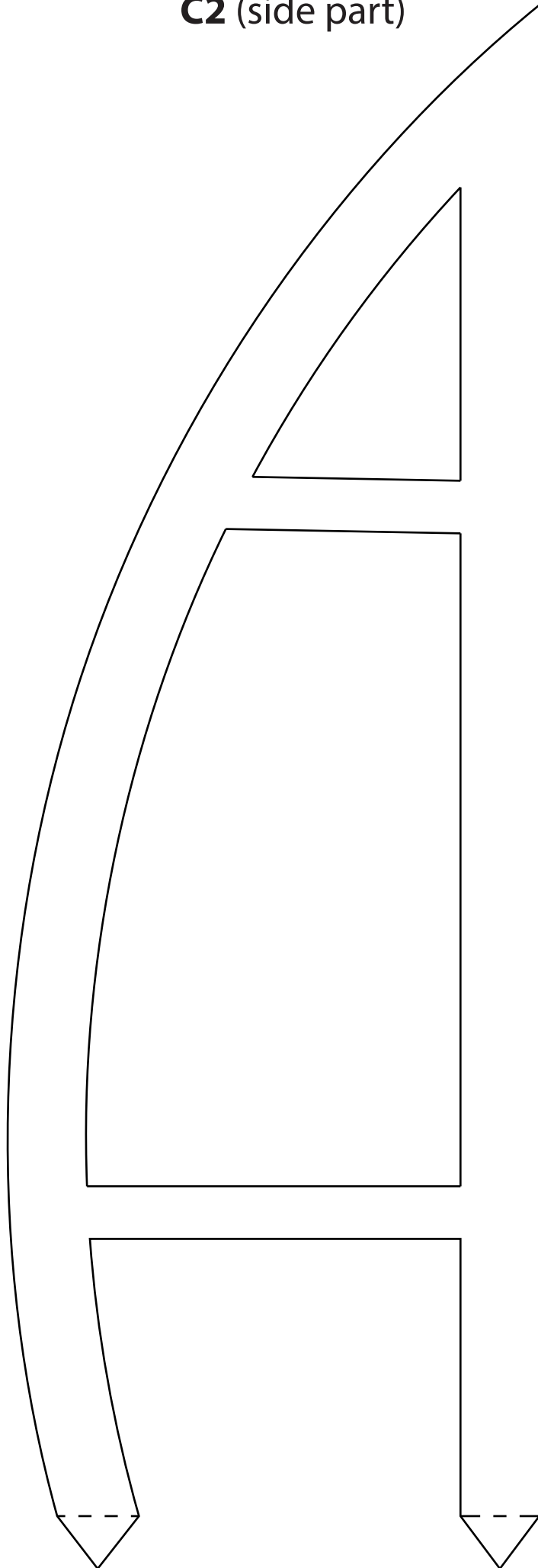



**ARCHITECTURE**

*with sauce* 

This tinker set has been provided by ARCHITECTURE with sauce, a project dedicated to offer crafting models.

Be sure to upload your building to the official gallery after you decorated it with colors or glitter: [www.craftingmodels.com/upload/](http://www.craftingmodels.com/upload/)

You can share your artwork on social media using the tags #craftingmodel #burjalarab and #dubai.

Hungry for building more? You can download additional crafting sets directly online at [www.craftingmodels.com](http://www.craftingmodels.com)



## Burj Al Arab

CRAFTING MODEL 1:1000

difficulty: hard 



Visit the world's largest database of skyscrapers and tall buildings on [www.skydb.net](http://www.skydb.net). Be sure to also follow @skydb\_net on social media.