



ARCHITECTURE

with sauce 

Print out all parts and paint them in your favorite colors, before cutting them out.

Glue the page containing the building body onto a piece of thick paper.

Cut out all parts with scissors.

Use a ruler and a wooden stick to scratch the black dashed lines, this will make them fold easier.

Add all parts to the body step by step. The instructions on the next page will help you to do so. Afterwards, decorate your tower!

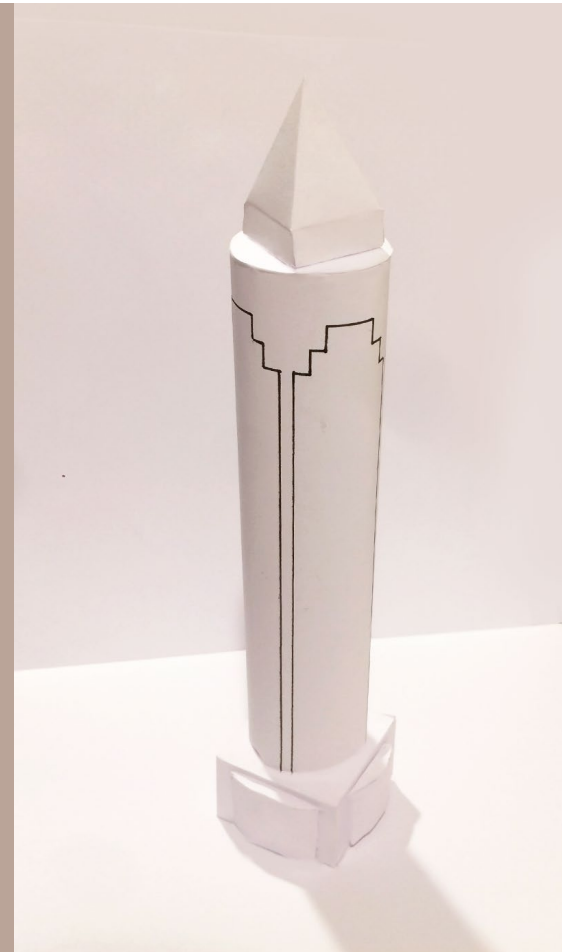

MESSETURM

CRAFTING MODEL

JUNIOR VERSION

SIMPLIFIED



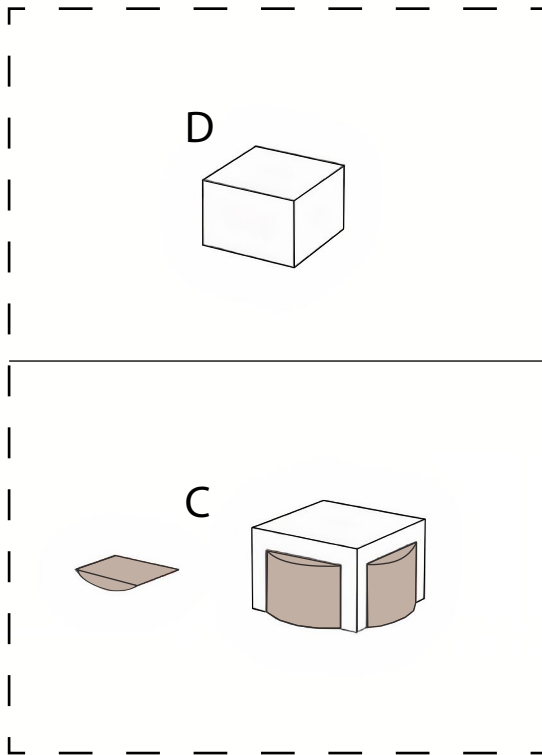

Fold the base and glue it together. Afterwards, stick the windows to its sides.

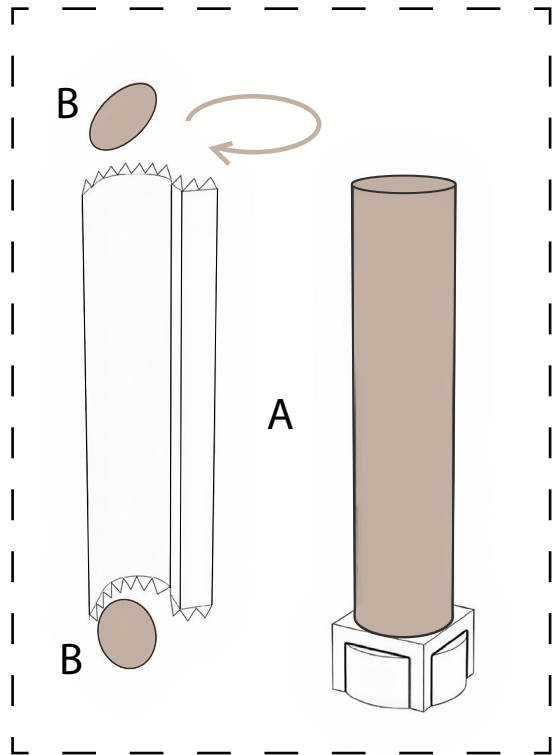

Fold the cylindrical body, close boths ends with covers, and attach the body to the base.

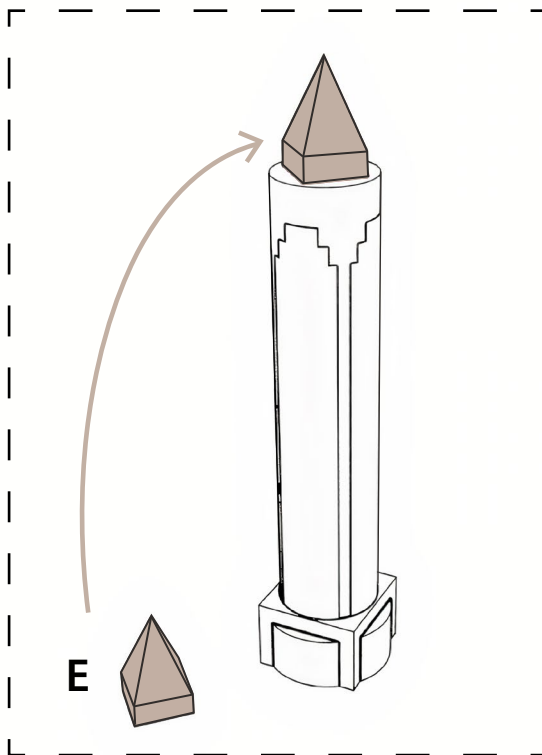

Finally, fold the pyramid, and attach it to the top.

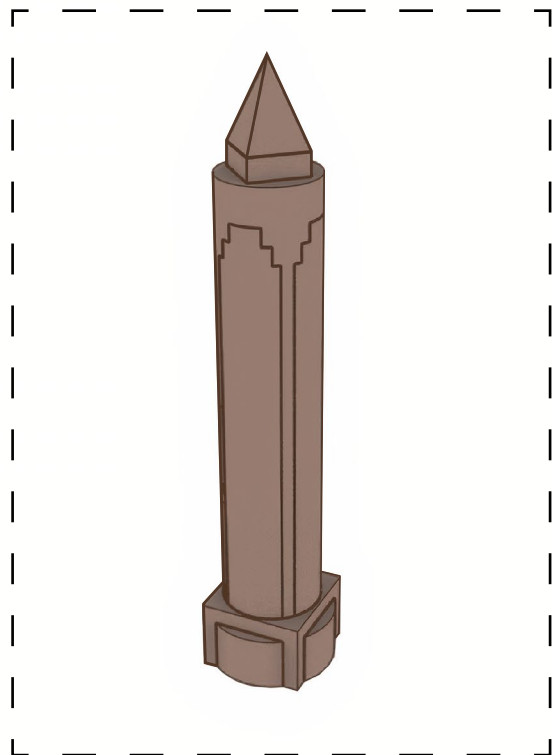

Congratulations, you did it!
To share your artwork with others,
please see the last page.

A (circular body)

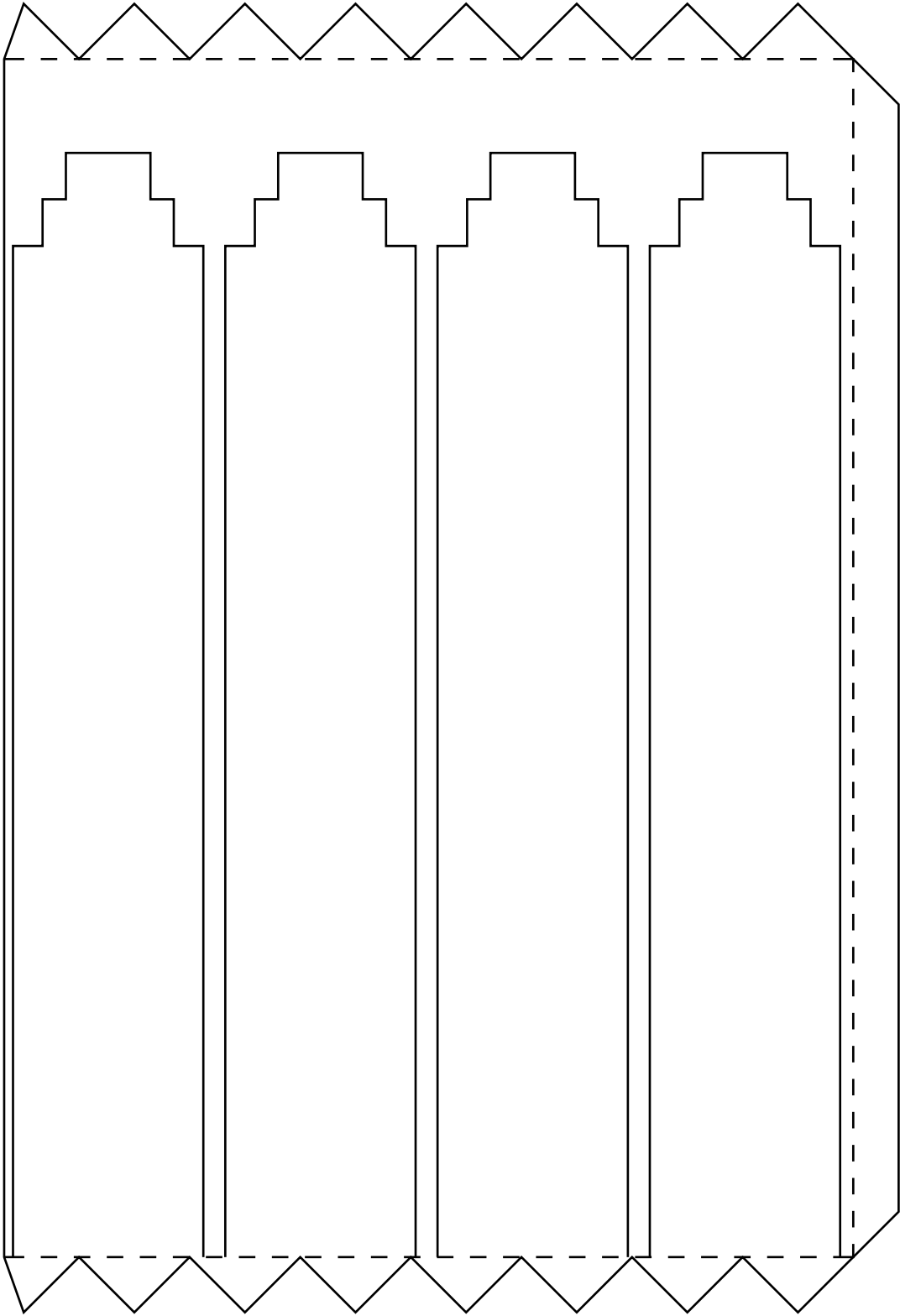

D (base)

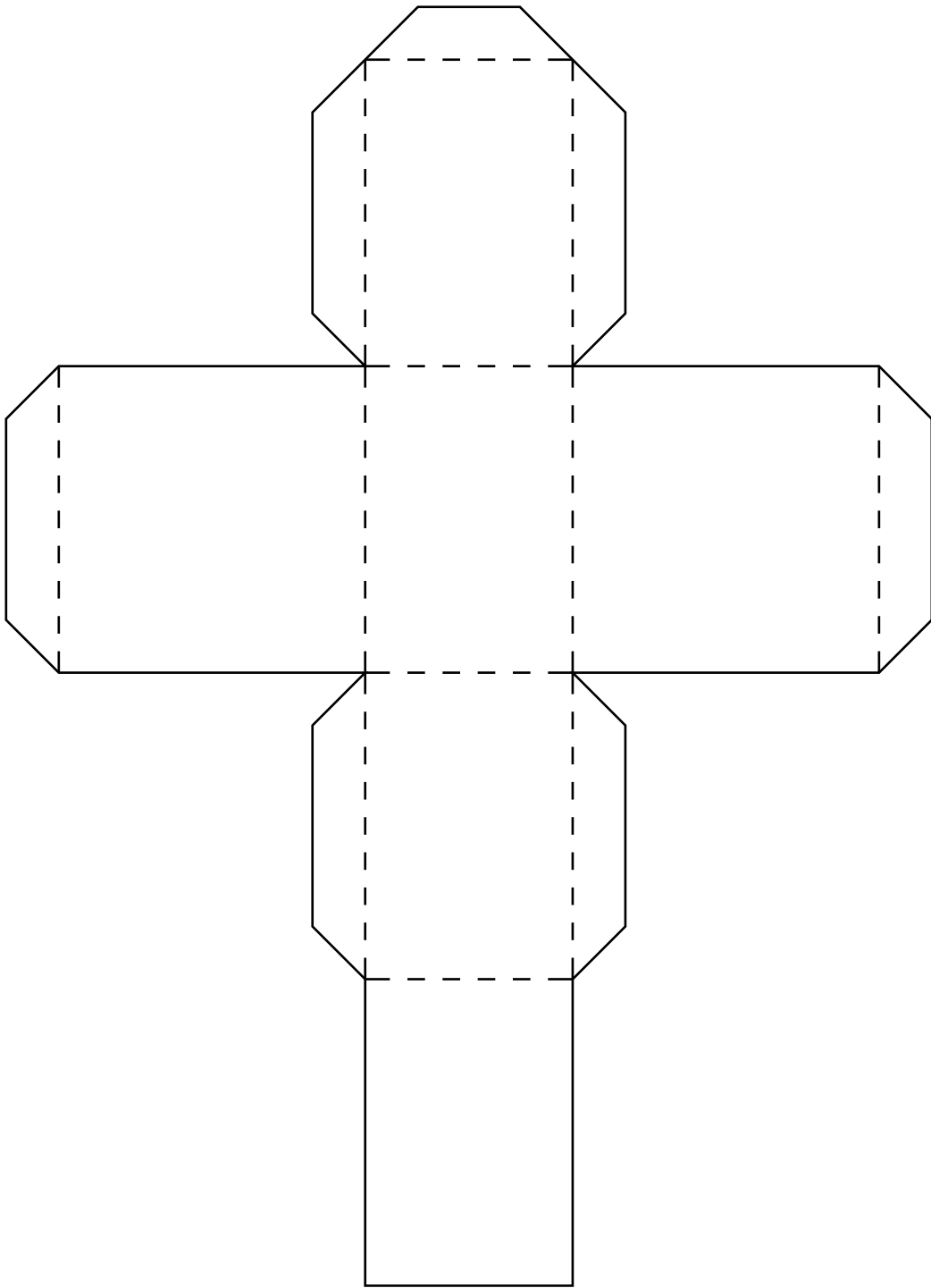

C (windows)

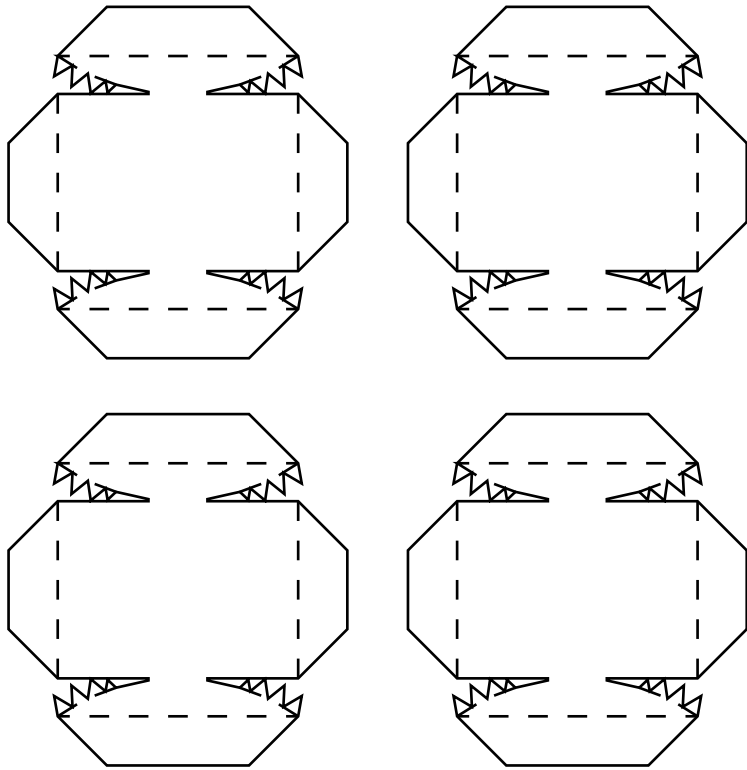

E (pyramid)

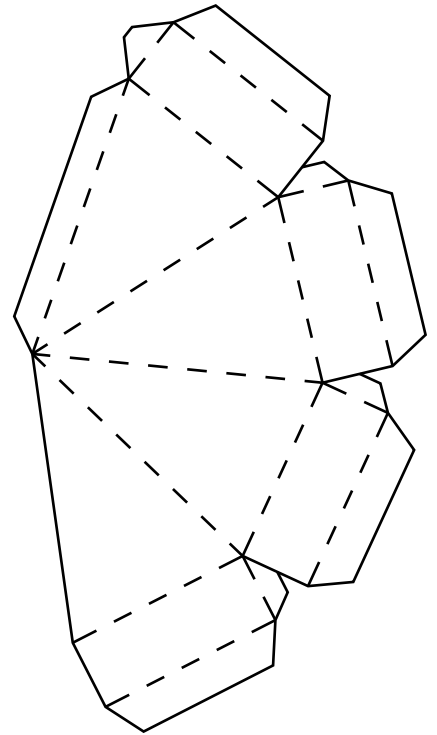

B (covers)

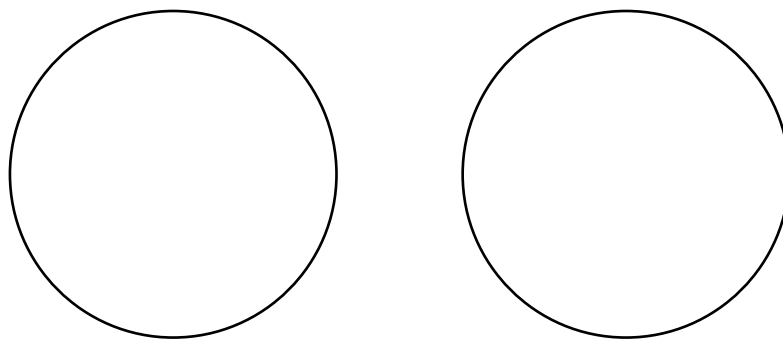



ARCHITECTURE

with sauce 

This tinker set has been provided by ARCHITECTURE with sauce, a project dedicated to offer crafting models.

Be sure to upload your building to the official gallery after you decorated it with colors or glitter: www.craftingmodels.com/upload/

You can share your artwork on social media using the tags #craftingmodel #frankfurt and #messeturm.

Hungry for building more? You can download additional crafting sets directly online at www.craftingmodels.com

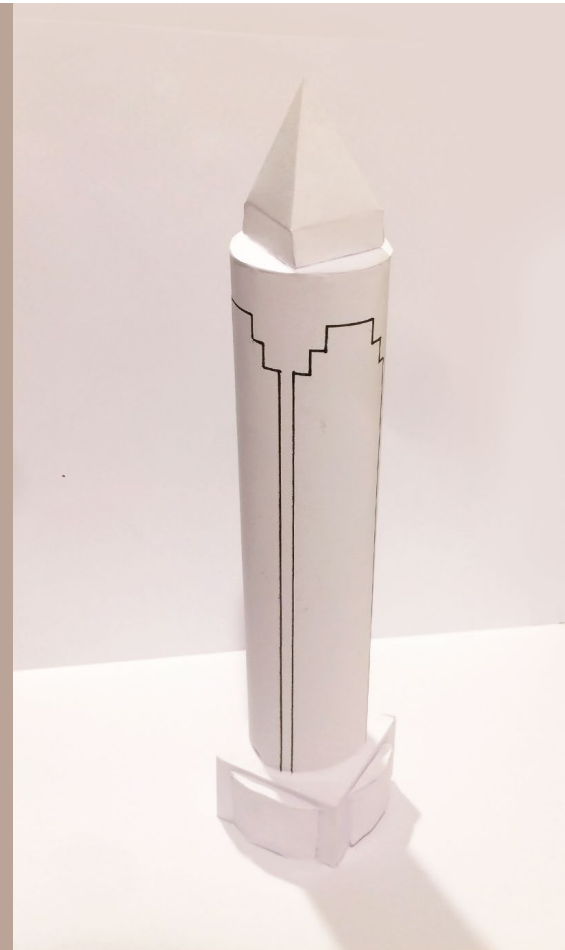

MESSETURM

CRAFTING MODEL 1:1000

difficulty: medium

