



ARCHITECTURE

with sauce

Print out all parts and paint them in your favorite colors, before cutting them out.

Glue the page containing the building body onto a piece of thick paper.

Cut out all parts with scissors.

Use a ruler and a wooden stick to scratch the black dashed lines, this will make them fold easier.

Add all parts to the body step by step. The instructions on the next page will help you to do so. Afterwards, decorate your tower!



Frankfurt TV Tower

CRAFTING MODEL

The creation of this crafting set
was made possible by:



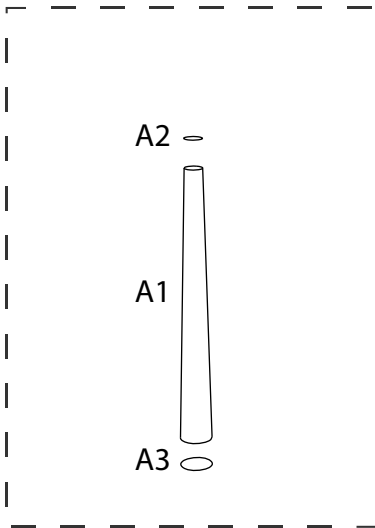

Roll the shaft and attach the covers.

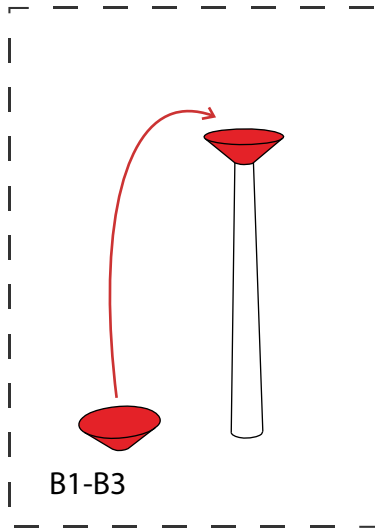

Mount the pulpit on top of the shaft.

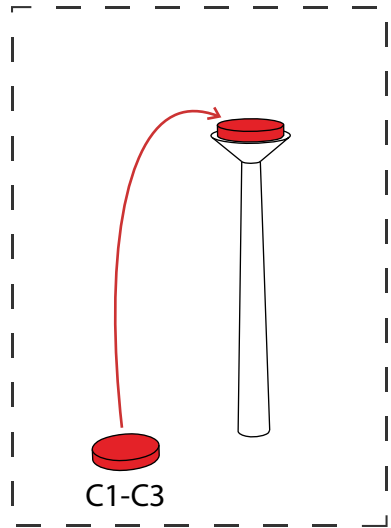

Add the rooftop to the existing structure.

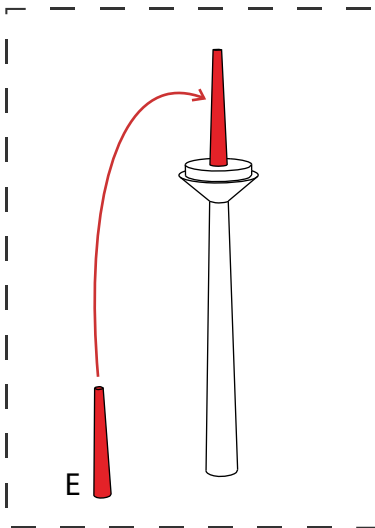

Roll the antenna and attach it to the top of the tower.

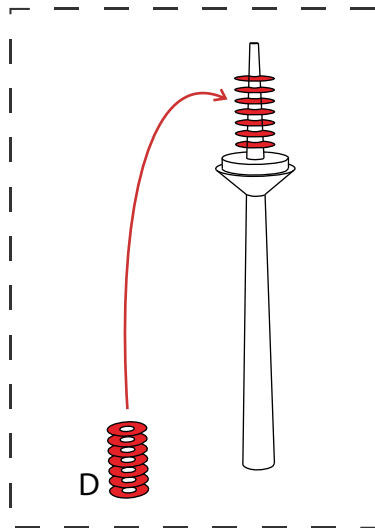

Add the rings to the antenna.

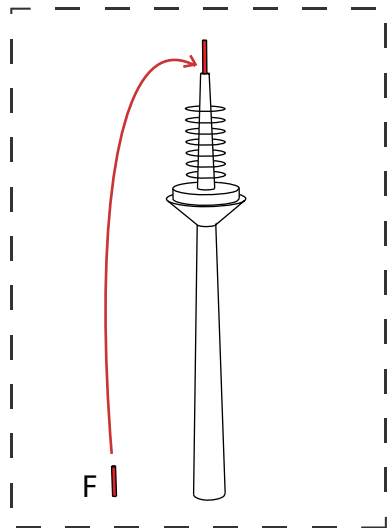

Roll the tip and attach it to the antenna.

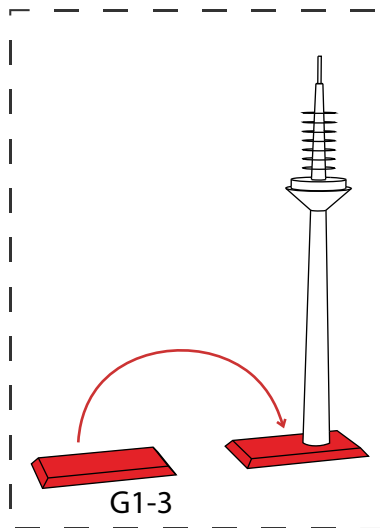

Add the base to the bottom of the structure.

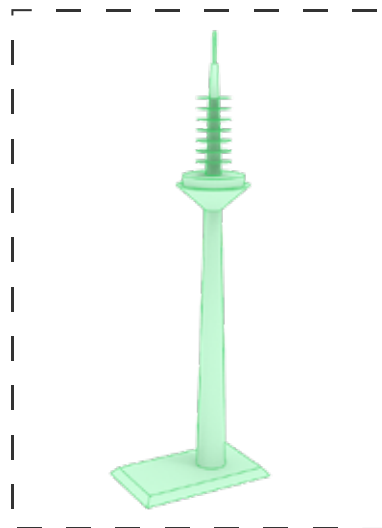

Congratulations, you did it!
To share your artwork with others,
please see the last page.

A (shaft)

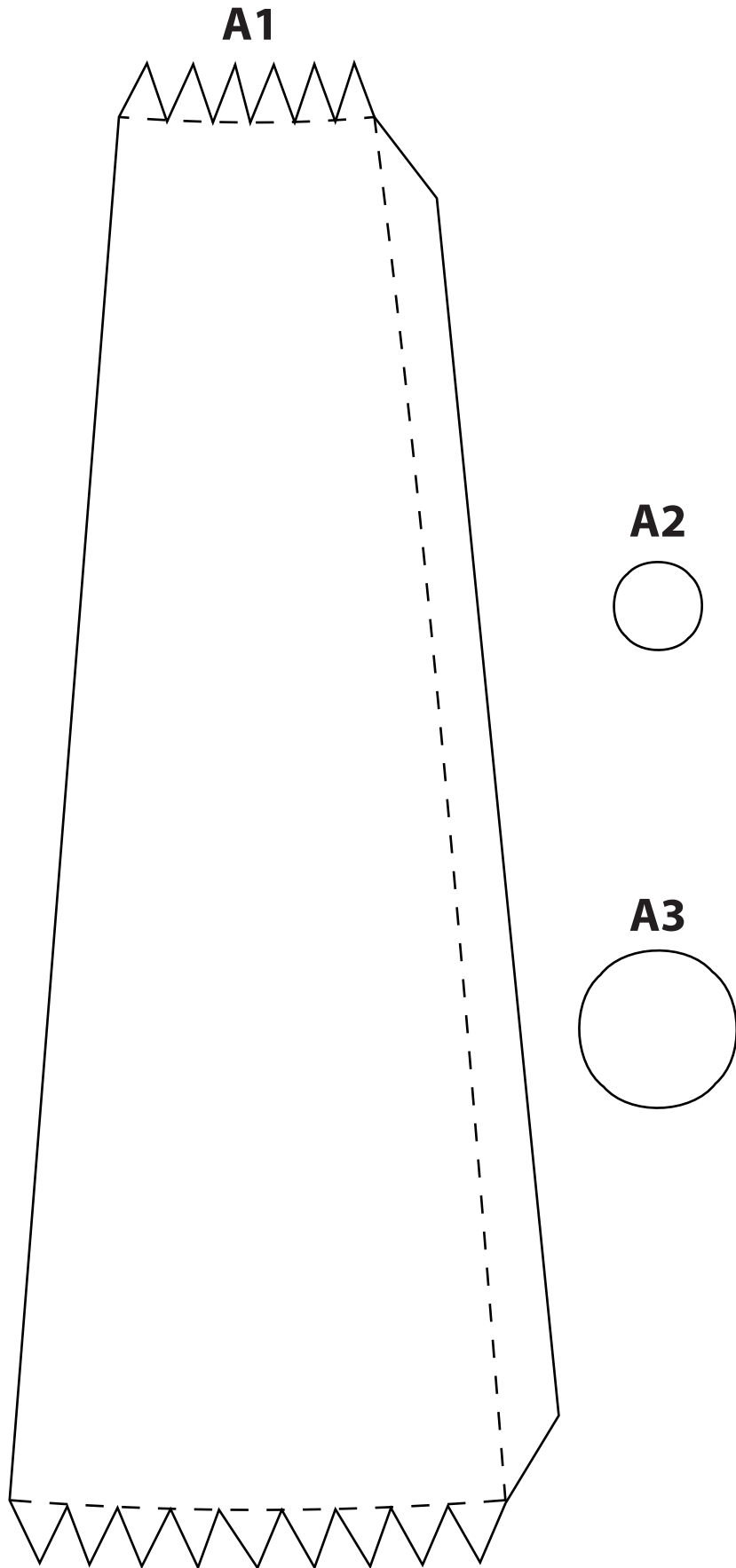

B (roof)

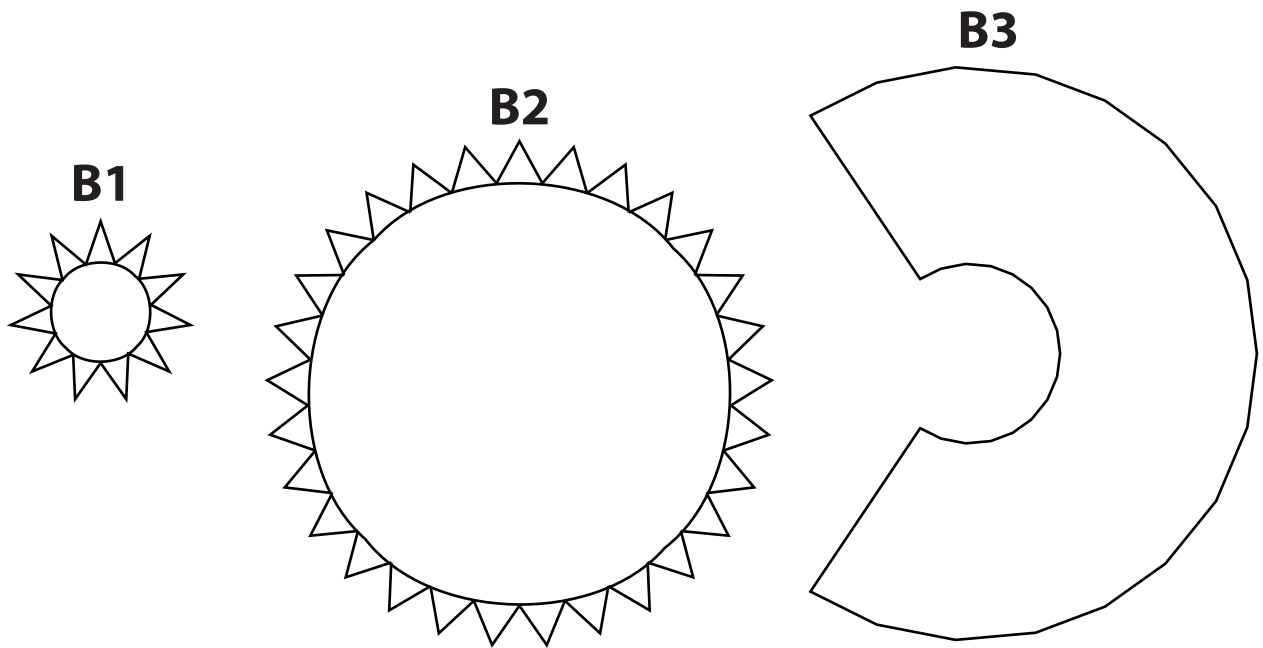

C (rooftop)

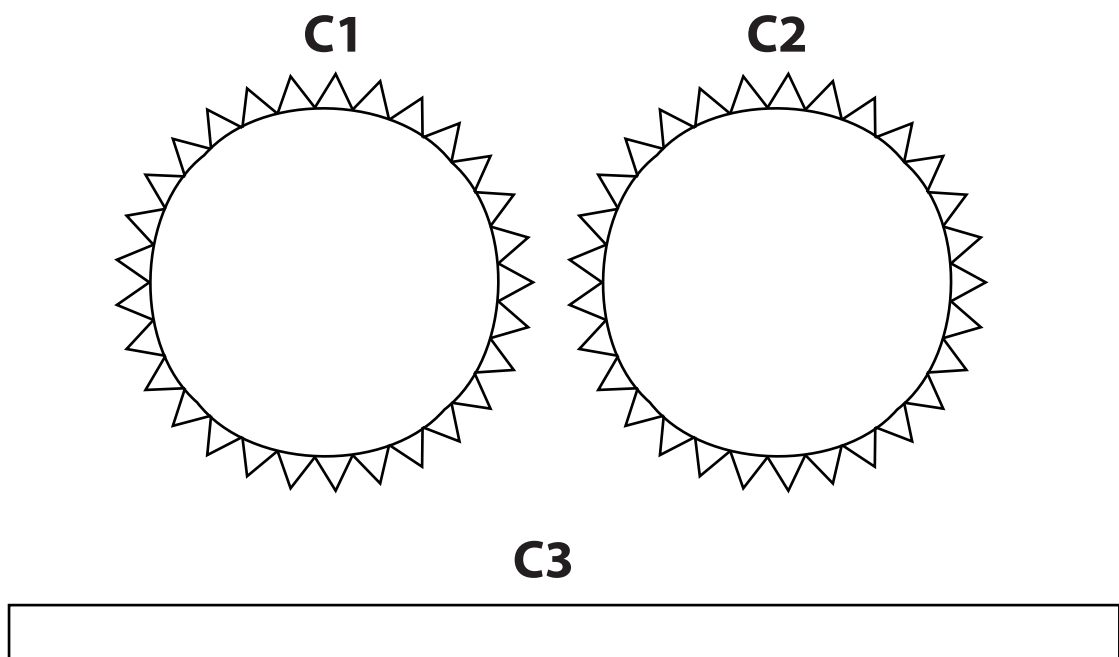

D (antenna dish)

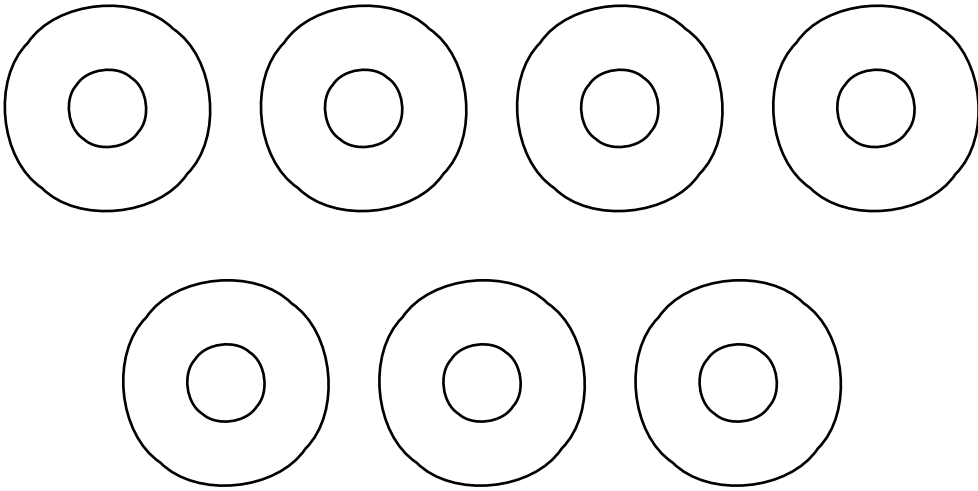

E (antenna)

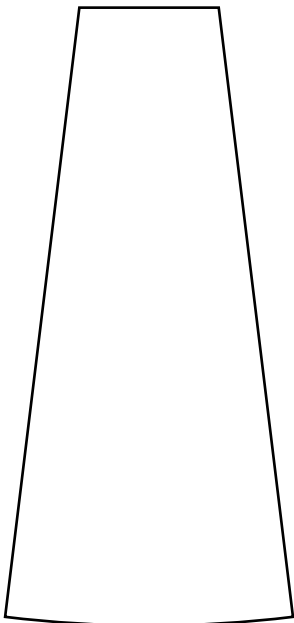

F (tip)

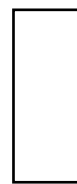

G (base)

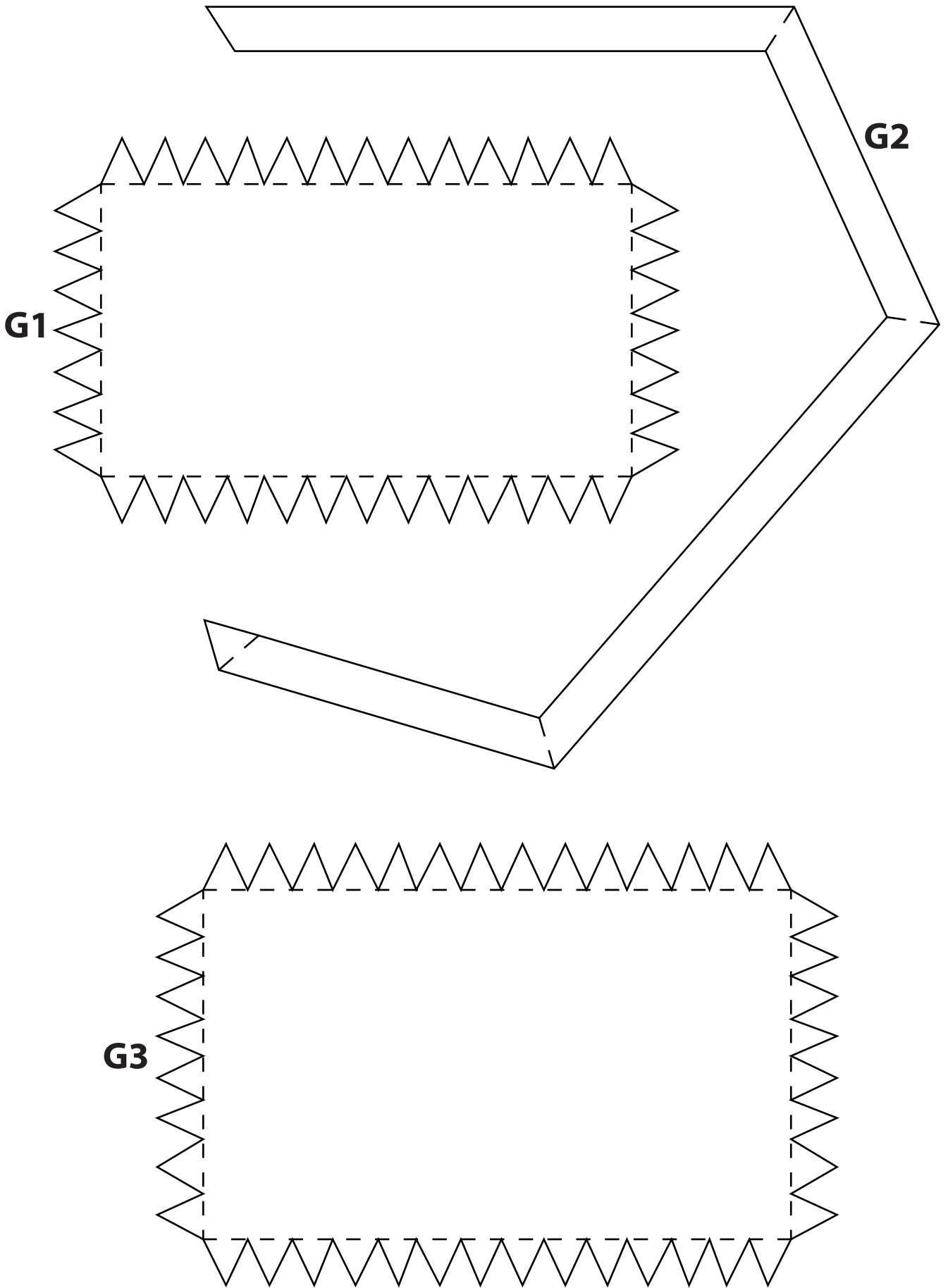



ARCHITECTURE

with sauce 

This tinker set has been provided by ARCHITECTURE with sauce, a project dedicated to offer crafting models.

Be sure to upload your building to the official gallery after you decorated it with colors or glitter: www.craftingmodels.com/upload/

You can share your artwork on social media using the tags #craftingmodel #europatum and #frankfurt.

Hungry for building more? You can download additional crafting sets directly online at www.craftingmodels.com



Frankfurt TV Tower

CRAFTING MODEL 1:1000

difficulty: easy 



To get more insights about the skyline of Frankfurt, its past and future developments, please visit us on www.skylineatlas.com - and follow us on social media.